

Utica-30"Vanity combo drawing

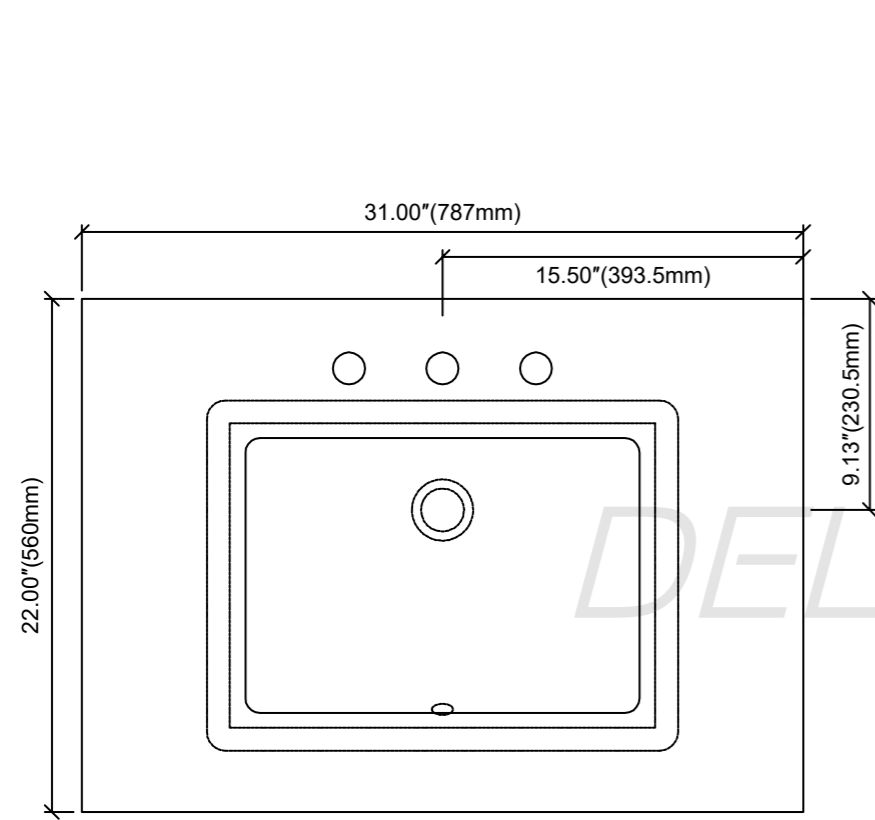

TOP VIEW

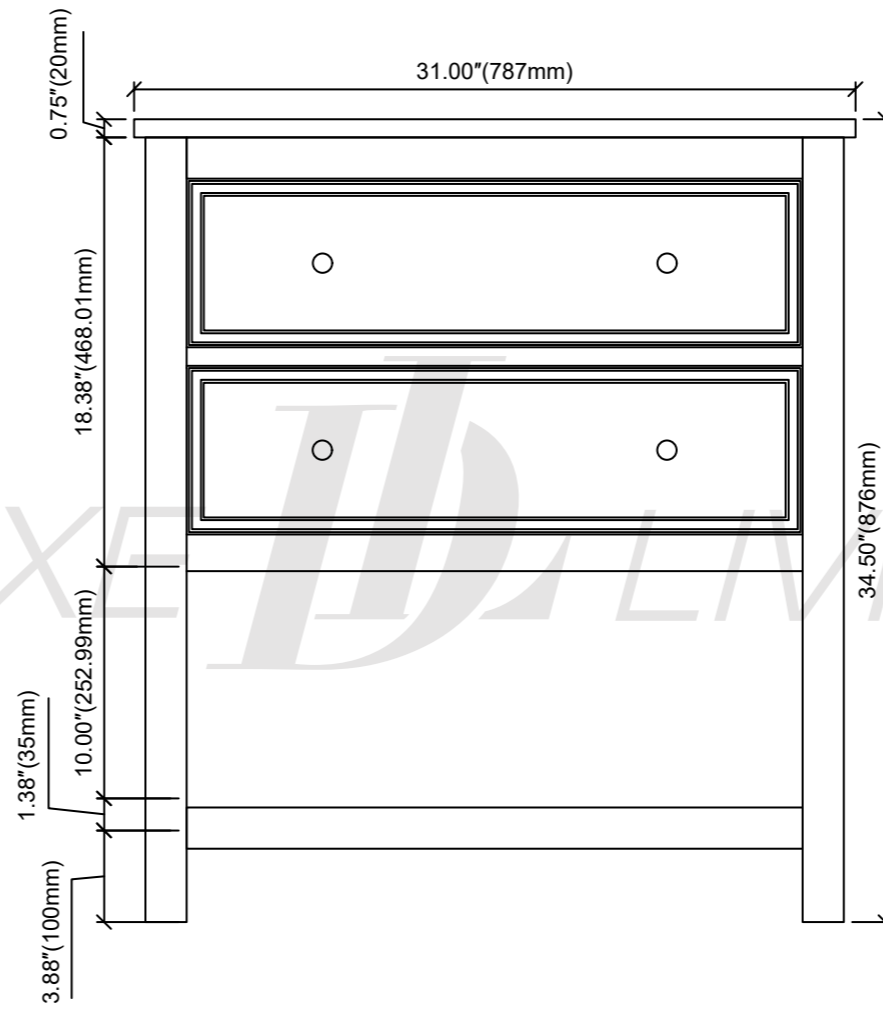

FRONT VIEW

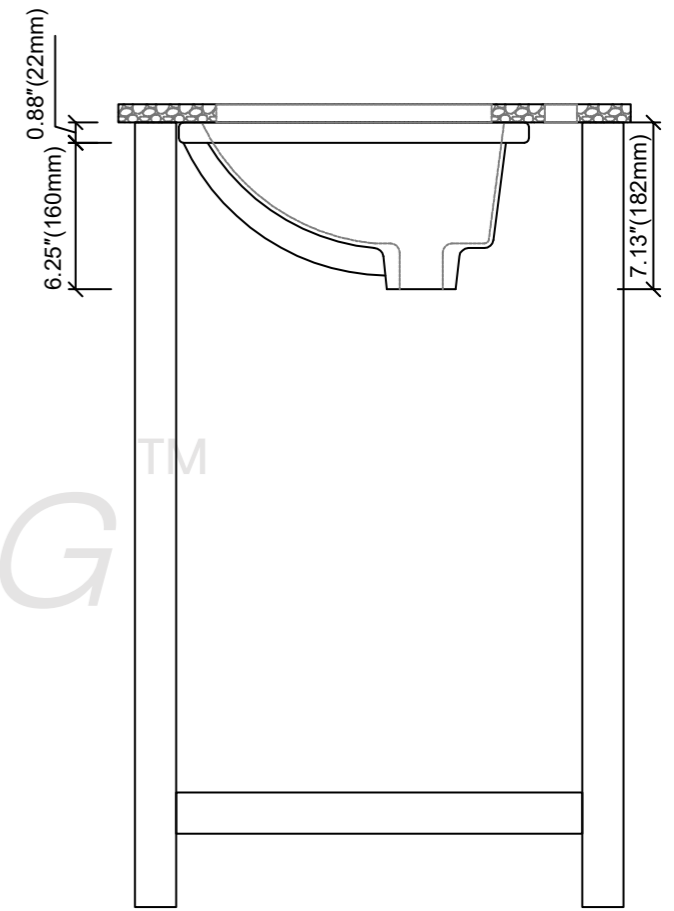

SIDE VIEW